



SRTTU

Journal of Computational and Applied Research
in Mechanical Engineering

jcarme.sru.ac.ir

JCARME

ISSN: 2228-7922

Research paper

Analysis and implementation of the solar tree by determining the optimal angle in Shiraz-Iran

Meraj Rajae* and Mina Jalali

Department of Electrical Engineering, Technical and Vocational University (TVU), Tehran, Iran

Article info:

Article history:

Received: 16/05/2021

Revised: 03/09/2021

Accepted: 06/09/2021

Online: 09/09/2021

Keywords:

Solar tree,
Optimized slope,
Shadow effect,
Solar charger,
Solar energy.

*Corresponding author:

mrjaee@tvu.ac.ir

Abstract

The solar tree is a combination of technology and art that is considered as the application of solar energy in the art of urban architecture. This study aims to combine solar technology with architectural style and art, to help urban beautification and investigate the increase in solar panels' efficiency by focusing on the optimal slope and no shading in the form of a new solar tree structure. In this paper, the best angle for placing panels on tree branches to increase Shiraz's maximum efficiency has been calculated. The best angle is done with the help of the NRI mathematical model. Also, the Fibonacci sequence, which originates from nature and real trees, has been used to minimize shadows on this tree. The panels' optimal slope calculations are performed using MATLAB software. Also, the monthly efficiency changes resulting from the optimal slope have been calculated and displayed. By analyzing the computational relationships and their implementation by PVsyst simulator, the optimal annual slope of solar panels obtained 30 degrees. By implementing it in the solar tree structure, the proposed annual efficiency of the model has increased by 12% compared to the fixed state. This article examines the technical methods of using solar systems in urban architecture with emphasis on integration methods. In the proposed and implemented solar tree model with the ability to adjust the optimal angle and beautify passages, parks and recreation centers, it is possible to charge electronic equipment such as mobile phones, tablets, and electric bicycles through clean solar energy.

1. Introduction

The two significant challenges of environmental pollution and the limitation of fossil energy resources in the world have made energy one of the most significant crises of the 21st century [1]. Restrictions on non-renewable resources have led researchers to study the use of pure and

renewable energy [2]. Given the increase in population and uncontrolled consumption without saving, this great blessing will undoubtedly end in the not too distant future [3]. Perhaps in the meantime, some countries are somewhat safe due to their abundant fossil fuel resources [4]. Using the right consumption methods, optimizing energy consumption, and

using renewable energy can control and curb the energy challenge [5]. Solar energy is of great importance among renewable energies due to less environmental pollution, free and easier access, and more [6].

In recent years, there have been many studies on the use of solar energy. Most of these studies have been done to increase the efficiency of previously made models, but in some cases, new and innovative technologies are seen as a good step towards the use and utilization of solar energy [7].

A method for improving the performance of photovoltaic cells was proposed; in this method, semi-Fresnel, the trigonometry was used to determine the refraction and convergent, and by using Snell's law, the groove angle for each groove angle of orthogonal incident ray was determined. The feature of this concentrator is its lower loss and aberration compared to a conventional structure with a Fresnel lens. It also reduces the number of solar cells needed to receive the sunlight [8].

Today, various methods have been used to extract solar energy, and researchers are also looking for ways to make the most of solar energy, given that the earth plays an essential role in all matters, including industry, agriculture, and construction. In addition to proper use of the sun, the proper use of the occupied land area must be considered [9]. On the other hand, urban beautification and architecture have become a management problem due to high costs and lack of resources; recently, artificial trees have been used for beautification, including high electricity consumption. The alternative solution proposed in this article is the use of solar trees [10].

The direct conversion of sunlight to electricity is what solar photovoltaic technology is all about [10]. A small portion is converted to energy, while the remainder is wasted as heat [11]. The output temperature of the PV plate increases as a result of this. Increases in operating temperature have an effect on the conversion performance and lifetime of photovoltaic panels. As a result, a proper cooling system is effectively needed to keep the module's operating temperature within the defined limit in order to achieve higher electrical performance and increase service life

[12]. Studies have been done on forced and forced air cooling, water spray cooling, phase shift cooling, heat pipe cooling, and liquid immersion cooling to improve the efficiency of PV panels [13]. Articles on various cooling methods, such as forced and forced air cooling, water spray cooling, phase shift cooling, heat pipe cooling, liquid immersion cooling and forced circulating water circulation, are used to improve the efficiency of PV panels [14]. Passive evaporative cooling is another of these techniques for controlling the temperature rise of the PV module and increasing performance by lowering the temperature of the PV panel by around 12 degrees Celsius, 7.7% increase of the total electrical energy output efficiency [15].

According to the literature, the amount of voltage, current, and output power per $10 \frac{mgr}{m^2}$ of sand is reduced by 5% and 13%, respectively, compared to the clean panel. The proposed solution is a cleaning system to remove contaminants. In order to increase the efficiency, in addition to the optimal slope defined, a cleaning system is also used [16, 17]. In this regard, super-hydrophobic coatings are also a good suggestion for removing contaminants because there is no need for manual control and panels' high efficiency [18]. In addition to the optimal slope and measures taken to reduce the shadow effect, this technology increases the efficiency of the panels [19].

The geographical location of Iran, which is located in orbits of 25 to 40 degrees north latitude and an area with the highest terms of receiving solar energy in the world that has an annual presence of more than 280 sunny days, shows the high importance of determining the optimal angle [20].

In a solar PV tree (SPT), unlike a land based PV array (SPV), all panels do not produce the same amount of power at an instant of time. This is due to the fact that panels in a SPT are oriented at different angles to cover the sun path of the location, hence every panel receives different amount of sunlight. Other drawbacks include complicated design and higher cost due to an aesthetically pleasing steel structure for panels and shading effect due to random orientation of the panels [21, 22]. However, this paper aims to tackle the drawbacks with the help of NRI

model for finding the optimized slope, Fibonacci sequence for avoiding shade effect, and an intelligent way for controlling the solar tree. Also, the study tries to design a tree solar system and generate electricity with not only economic and environmental benefits, but also to beautify the urban landscape [23].

Solar trees have different divisions, one of which is related to their structure [24]. The structure of a solar tree can be movable or fixed. Fixed structures have advantages such as cost-effectiveness and disadvantages such as less light absorption during the day, shading of the panels on top of each other, a fixed slope and no efficiency change in different seasons of the year [25].

According to research on heat transfer, the investigation of the maximum and minimum Nusselt number showed that in the same conditions, moving the baffles arrangement increases the Nusselt number [26]. The innovation of this study is to investigate the combination effect of the thermal radiation and convection in the hybrid heat transfer between solid and fluid in a channel [27].

GIS is a powerful tool for the analysis of data, maps, and spatial information which has been used as a means of studying the optimal location for the construction of a solar power plant in recent years. Concerning Iran, as the results of the present work in Fig. 1. also suggest, it is reported that provinces in the southern half of the country have adequate potential for using solar energy.

Having 280 sunny days per year in more than 90% of the country's areas, much research is conducted on solar energy in Iran. It is reported that solar energy is the most available and cleanest type of energy in Iran. However, being rich in oil and gas resources and the availability of cheap national grid power, solar energy is not used to its full potential in Iran [28].

In this article, a panel with the specifications shown in Table 1 has been used.

Table 2 shows the standard structure of the solar trees.

In this article, the solar tree is presented using the Fibonacci pattern. The features of this pattern include:

- Commonly seen in nature

- The trees capture light efficiently as the Fibonacci pattern enables all leaves to face the sun directly

- It has been reported to have performed better than the flat-panel model.

In the material and method section, first, the method of calculating angles by the Fibonacci pattern is discussed. The algorithm for calculating the maximum radiation and power received from the panels is introduced. After stating the details of calculating the optimal slope, the amount of direct and scattered radiation in two optimal angles and the horizontal angle are compared in the results section. Also, the increase in efficiency and the effect of optimizing the angle of the panels are shown in detail.

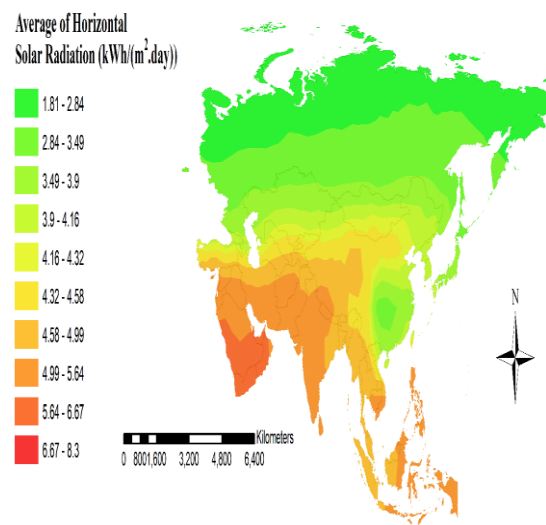

Fig. 1. Average radiation on a horizontal surface for Asian countries [28].

Table 1. The used panels specifications.

Model	RL-0605
Material	Monocrystalline
Maximum working voltage	18V
Maximum working current	0.83 A
Maximum output power	12 W
Panel's area	$20 \times 16 = 320 \frac{cm}{m^2}$

Table 2. The standard structure of the solar trees.

Structure	Description	Benefits	Limitations
Single trunk with branches [29]	<ul style="list-style-type: none"> Simple imitation of a natural tree consisting of a central pole as the trunk of the tree and branches surrounding it at various levels It consists of all panels oriented at a particular set of angles. 	<ul style="list-style-type: none"> Simple design Very easy to develop Lesser cost than other designs 	<ul style="list-style-type: none"> Less efficient in light capture as all panels are oriented in the same direction Ineffective in capturing sunlight throughout the day
Hemispherical semi-dome design. [19]	<ul style="list-style-type: none"> It is basically designed to cover the complete sun path. It consists of panels oriented in the south, southeast and southwest directions to capture sunlight from morning to evening. 	<ul style="list-style-type: none"> Effectively captures sunlight throughout the day. High power output. High efficiency 	<ul style="list-style-type: none"> Slightly costly due to large number of panels
Spiraling Phyllotaxy solar tree [30]	<ul style="list-style-type: none"> Most common Phyllotaxy displayed by plants in nature A line is touching the bases of successive leaves forming a spiral (genetic spiral) on the stem This arrangement of leaves helps to improve the sunlight capturing of the solar tree 	<ul style="list-style-type: none"> Highly efficient in light capture. Higher power yield Very closely mimics natural trees 	<ul style="list-style-type: none"> Very complicated design, difficult to fabricate. Costly due to the massive steel structure. Consumes lots of space for its leaves.
Panels on natural trees [31]	<ul style="list-style-type: none"> Solar panels can be installed on a natural tree with fewer branches (like a palm tree) instead of a metallic frame. This approach will reduce the cost and resource requirement of the solar tree and will give a more natural look to the architecture of the structure. The shape of a tree plays an important role in the orientation of panel. 	<ul style="list-style-type: none"> Simple design as the frame is not required. Very low cost (lowest among all designs) Natural appearance 	<ul style="list-style-type: none"> Dependent on the shape of a tree. Less effective in light capture due to shading from the natural tree Only applicable to low power applications

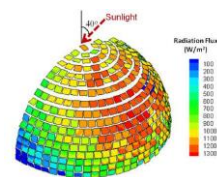

2. Materials and methods

2.1. Effect of shadows

The power output of the photovoltaic system is directly related to the amount of sunlight on the panel surface. Therefore, the angle of sunlight on the panel and environmental factors such as shadow and slope of the panel installation can lead to changes in the output power of the panels. In hours when the intensity of sunlight is high, if a shadow falls on the solar panel at the shadow edges due to light refraction, the intensity of the radiation will be very high. This is called the shadow effect or the edge effect.

The location of the panels should be chosen so that we have the least shadow effect. In addition to environmental conditions, the angle of the panels has a significant impact on increasing their efficiency. It should also be borne in mind that changes in environmental factors are unlikely and that panels may be required in these areas. Therefore, determining the appropriate slope for optimization is very useful. In addition to the optimal slope, this article can prevent the shadow effect.

2.1.1. Solution of the effect of shadow

Trees absorb light efficiently due to the orientation and distribution of their leaves. The fractional ratio of the number of branches to the number of rounds of the tree varies for different trees, and this value varies according to the Fibonacci sequence. Fig. 2. shows a five-pronged tree in two rounds. If x determines the number of branches and y determines the trunk rotations, this ratio is $\frac{2}{5}$ for Fig. 2. After studying and measuring different trees, Aidan Dier realized that the ratio is different for each tree in nature [32]. Using the Fibonacci pattern makes the panels have no shading on each other, considering the optimal slope in each area. In recent research, the shadow effect calculated by existing mathematical formulas has reached 17% [33]. Simulation and tree construction using the Fibonacci sequence and replacing the simulated tree leaves with solar cells can increase the efficiency of a set of solar cells that work together to generate electricity. In simple words,

the branches are placed on the tree's trunk and the leaves on the branches, which follow the Fibonacci sequence, to absorb maximum sunlight and prevent the panels from shading on top of each other [34].

The effect of shadow has been studied by researchers and the shadow effect has been reduced to less than two percent [35]. The angle between the panels is 120 degrees [25]. The solar tree made according to the Fibonacci technique can be seen in Fig. 3. The components of the tree are mentioned in detail below.

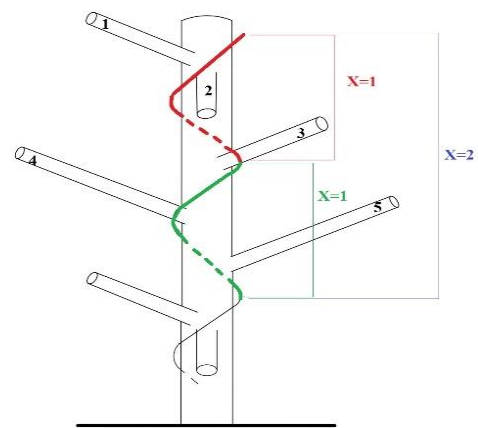

Fig. 2. The Fibonacci pattern's sample.

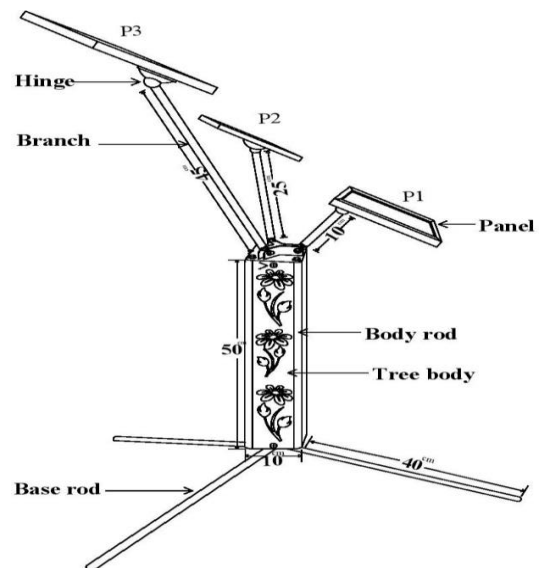

Fig. 3. The solar tree made according to Fibonacci pattern.

Fig. 4. shows the angles between the branches. In the built structure, the branches are separated from each other using metal partitions, and each of them can change the angle separately. The advantage of this design is that if the tree has been used in another location, it will not face any limitations and with a slight change, the shadow effect will disappear. Changing the angle makes the structure very flexible, which can be easily upgraded if a solar tracker is used.

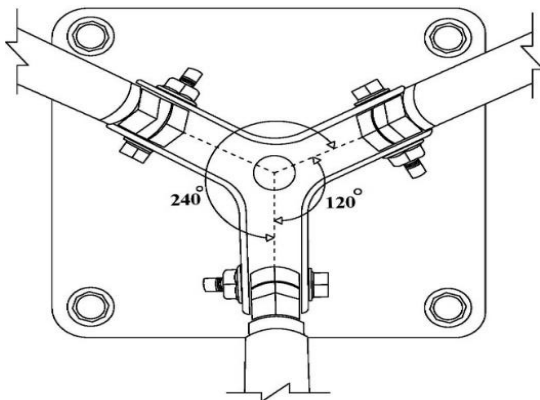

Fig. 4. Angles between branches.

This design can work as $\frac{1}{3}$ and also $\frac{3}{3}$. The difference in the size of the branches makes the tree's fixed plate reminiscent of the trunk of the tree; and the difference in their size can also be changed, that in practice, these two ratios are achieved with one structure being equivalent.

2.2. Optimal angle

There are various mathematical models for measuring the radiation of the sun on the surface of the panels to get their Maximum extractable output. It should be noted that the difference between these mathematical models is only in the way of calculating scattered radiation; of course, the complexity of the calculations is what has caused the difference between the models. In this paper, the NRI model is used to estimate the solar energy potential.

2.2.1. NRI model

In this model, the solar radiant energy is calculated based on the altitude angle of the sun,

the cloud factor and the inclination angle. The amounts of direct and scattered sunlight on a plane are calculated from the Eqs. (1, 2) [35].

$$I_{b,n} = F_b(\delta)(1 - CF) \left[1 - \exp\left(-\frac{0}{075} \alpha\right) \right] \quad (1)$$

$$I_{d,h} = F_d(\delta)[0/123 + 0/181 \alpha + 10/43 CF] \quad (2)$$

$I_{b,n}$ refers to the intensity of the direct radiation on a vertical plane and $I_{d,h}$ to scattered radiation on a horizontal plane. Also, α is the angle of elevation and in terms of degree, C.F. is the cloud factor, and δ is the angle of the inclination. Also, the declination effectiveness coefficients, F_b and F_d are calculated in Eqs. (3-8) [36].

$$F_b(\delta) = C_{b1} \delta + C_{b2} \quad (3)$$

$$F_d(\delta) = C_{d1} \delta + C_{d2} \quad (4)$$

$$C_{b1} = -\frac{563}{8} \times 10^{-5} \left(\frac{KW}{\frac{m^2}{deg}} \right) \quad (5)$$

$$C_{b2} = \frac{0}{9876} \left(\frac{KW}{m^2} \right) \quad (6)$$

$$C_{d1} = -6/9 \times 10^{-5} (KW/m^2/deg) \quad (7)$$

$$C_{d2} = 0/0121 (KW/m^2) \quad (8)$$

Sunlight reaches the surface of the earth regardless of weather conditions, but its intensity decreases as it passes through the clouds. This type of radiation is called diffused radiation impacting the calculation of scattered radiation on cloudy and foggy days. Diffused irradiation is shown in Fig. 5. It should be noted that direct radiation is much stronger because sunlight reaches the surface of the earth without being blocked by clouds.

The total radiation received by the desired page can be written as follows in Eq. (9) [36].

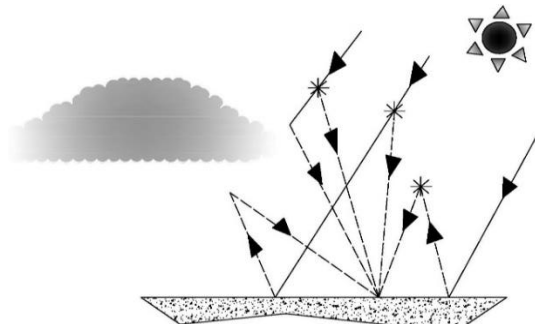

Fig. 5. Diffused irradiation.

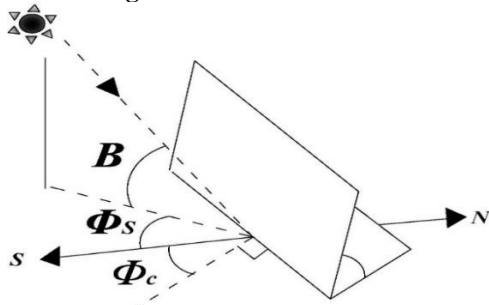

Fig. 6. Φ_c : panel angle with south, Φ_s : sun angle image with south and Σ : panel angle with the horizon.

$$I_{t.a} = I_{b.a} + I_{d.a} \quad (9)$$

$I_{b.a}$ represents direct radiation, and $I_{d.a}$ represents the scattered radiation for the screen. $I_{b.a}$ and $I_{d.a}$ are calculated by Eqs. (10, 11) [36]

$$I_{b.a} = I_{b.n} \cos \theta_i \quad (10)$$

$$I_{d.a} = I_{d.h} \left(\frac{1 + \cos \beta_i}{2} \right) + \rho_{alb} I_{t.h} \left(\frac{1 - \cos \beta_i}{2} \right) \quad (11)$$

where θ_i is the angle of impact (angle of solar radiation with the average plane vector), β_i is the slope of the plane relative to the horizon, ρ_{alb} is the reflection coefficient of the surface of the earth, and $I_{t.h}$ is the intensity of the total radiation on a horizontal plane calculated by Eq. (12) [36].

$$I = I_{b.n} \cos(90 - \alpha) + I_{d.h} \quad (12)$$

The angle of collision θ_i for any plane with an angle of deviation β from the horizon and an angle of inclination γ concerning the north axis can be calculated in terms of the angle of

inclination of the sun δ and the angle of incidence ω and latitude φ at any time [36]. For a fixed plane, the angle of incidence is obtained according to Eq. (13) [36].

$$\begin{aligned} \cos \theta_i &= \cos \beta (\sin \delta \sin \varphi \\ &+ \cos \delta \cos \varphi \cos \omega) \\ &- \cos \delta \sin \omega \sin \beta \sin \gamma \\ &+ \sin \beta \cos \gamma (\sin \delta \cos \varphi \\ &- \cos \delta \cos \omega \sin \varphi) \end{aligned} \quad (13)$$

In this case $\beta_i = \beta$.

In Fig. 6., the angles Φ_c are called the azimuth angle, which is the angle of the panel with the south which has a negative value in the southwest. The angle Φ_s is called the sun's elevation angle and represents the angle of the image of the rays of the sun with the south, and Σ is the angle of the panel with the horizon.

The electrical energy generated by the photovoltaic cell is calculated by Eq. (14) [36]

$$E = \frac{1}{n_f - n_s + 1} \sum_{n=n_s}^{n_f} \left[\int_{sunrise}^{sunset} I_{t.a} dt \right]_n \quad (14)$$

where n , n_s , and n_f are the number of the desired day, the beginning and the end of the time interval, respectively, and the time of integration of sunrise and sunset in each day. As shown in the above formula, the integration interval values are different for each day, but the value in these calculations is considered from 7:30 to 16:30 according to the shortest day of the year (December 21). Therefore, the values obtained will increase significantly, especially in the summer months.

2.3. Solution algorithm

Fig. 7 shows the flowchart for calculating the optimal slope and maximum energy that can be received in the structure. Accordingly, inputs that are generally fixed, such as the cloud factor, latitude and panel angle, typically zero degrees, are entered to obtain the amount of radiation and energy that can be received at the horizon. Also, this angle is changed from zero to 180 degrees to the south at the other entrance. According to the

formulas presented, the maximum monthly and annual radiations are calculated. Finding the best slope and calculate the maximum energy, in each step, 10 degrees are added to the panel angle, and by calculating the new direct and scattered radiation and entering the panel efficiency, which is a constant value of 20%, each time the energy from that degree is compared with the energy obtained from the previous angle. When the 18 steps of these changes are done, the maximum amount of the energy is adjusted to its angle. On the other hand, in the formula for calculating efficiency, we need a diary, which, by applying it, the best slope and maximum energy that can be received per month are obtained.

3. Results and discussion

3.1. Radiation analysis for tracking

With a latitude of 29 °, Shiraz city has medium cloudiness and average temperature compared to other Iran regions. The performance of the NRI model is discussed by MATLAB software to calculate the maximum radiation and power received from the panels. The structure is analyzed only for the city of Shiraz.

3.2. Calculate the optimal slope

According to the flowchart description in the previous section, 18 samples are taken each month to find the maximum power. Tables 3 and 4. show these samples at every ten degrees change for each month of the year. After finding the maximum power, it is adapted to the relevant angle; and to find the optimal slope, ten more samples are taken in the interval where the maximum power is received; thus, the optimal slope for each month is calculated. The result of these calculations can be seen in Table 5. These values are the angle of the panel facing south, and the negative angle means the panel is sloped north.

Because the tree is made of semi-movable plates, it is necessary to calculate an angle with the highest efficiency, which according to Tables 3 and 4, has the highest output power in the range of 20-30 degrees to the south with ten samplings during this period. It is observed that the power

reaches its maximum value at an angle of 29-30 degrees to the south. The slope intended for building the tree is 30 degrees. One of the advantages of the solar tree is the ease of changing the angle of the panel on the branch. This feature makes building the solar tree not limited to a specific location and with minor changes, it has the highest panel efficiency in another location with different latitudes.

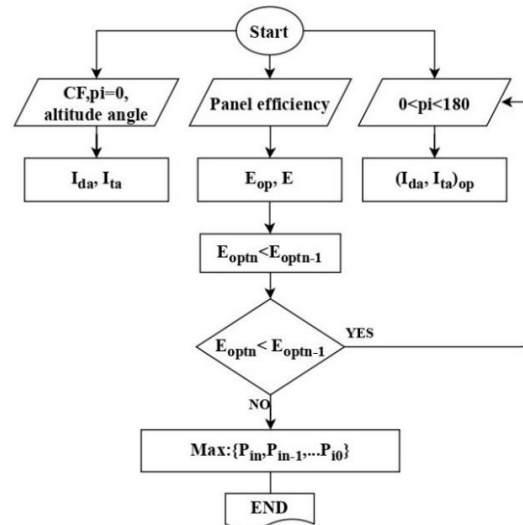

Fig. 7. The flowchart of optimized slope and maximum received energy calculation process.

Table 3. Samples of each month to find the maximum power (0 - 90).

Deg.	0	10	20	30	40	50
	to	to	to	to	to	to
	10	20	30	40	50	60
Jan.	3.1	3.3	3.73	4.25	4.5	4.41
Feb.	3.8	3.82	3.94	4.18	4.2	4.19
Mar.	3.7	3.81	3.92	4.1	4.08	3.99
Apr.	4.2	4.5	4.41	4.32	4.31	3.82
May.	4.9	4.7	4.68	4.58	4.51	4.48
Jun.	6	5.81	5.71	5.69	5.47	5.32
Jul.	5.4	5.37	5.31	5.18	4.91	4.89
Aug.	5	5.1	5.01	4.9	4.81	4.73
Sep.	5.4	5.53	6	5.89	5.81	5.78
Oct.	4.3	4.48	4.53	5.61	5.7	5.61
Nov.	3.9	4.2	4.31	4.51	4.55	4.6
Dec.	3.2	3.38	3.42	3.51	4.2	4.5
Ann.	5.1	5.5	6	5.82	5.63	5.58

Table 4. Samples of each month to find the maximum power (-90 - 0).

Deg.	-60 to -50	-50 to -40	-40 to -30	-30 to -20	-20 to -10	-10 to 0
Jan.	2.47	2.58	2.61	2.66	2.87	3.08
Feb.	2.97	3.21	3.62	3.68	3.71	3.76
Mar.	2.98	3.21	3.22	3.52	3.61	3.68
Apr.	3.59	3.62	3.81	3.97	4.01	4.18
May.	4.21	4.4	4.69	4.77	4.81	4.87
Jun.	5.23	5.43	5.51	5.68	5.73	6
Jul.	5.29	5.36	5.38	5.41	5.48	5.5
Aug.	4.71	4.73	4.75	4.81	4.88	4.91
Sep.	5.01	5.11	5.28	5.31	5.35	5.38
Oct.	3.69	3.81	3.88	3.91	4.11	4.28
Nov.	3.51	3.58	3.61	3.68	3.71	3.8
Dec.	2.61	2.73	2.80	2.83	2.9	3.1
Ann.	4.55	4.85	4.61	4.68	4.71	4.91

Table 5. The optimal slope in each months.

Months	Optimal tilt
Jan.	49
Feb.	46.5
Mar.	31
Apr.	15
May.	3
Jun.	-4
Jul.	-2
Aug.	12
Sep.	26
Oct.	41
Nov.	51
Dec.	55

3.3. Calculate the efficiency of solar tree

The amounts of direct and diffused monthly radiation are shown in Figs. 8 and 9. These values are obtained from Eqs. (10, 11). From now on H.S. is used for the values calculated at an angle of zero degrees, and O.S. is applied for the values calculated at an angle of 30 degrees. The values presented in Table 1. indicate the ideal state of the existing solar panel, according to which, by parallelizing the panels, the output power should be 8.9 watts with an efficiency of 20%. According to Eq. (14), a factor called total

radiation, also affects the resulting energy which can be seen in Figs. 8 and 9. Next, the energy of the panels is calculated in two angles of zero degrees and 30 degrees. Voltage, Current and Power in both H.S. and O.S. are shown respectively in Figs. 10-12. The shown values represent the year from January to December by numbering 30, 60, 89, 120, 151, 182, 213, 244, 275, 305, 335 and 365.

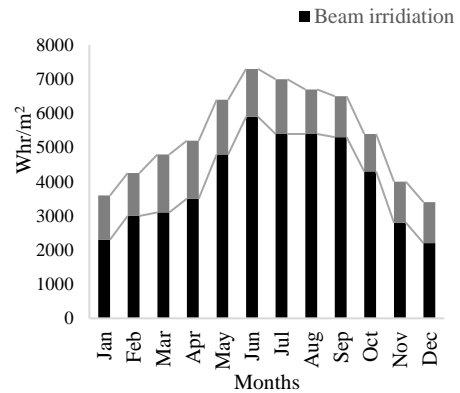

Fig. 8. The H.S. monthly quantities of direct and diffused irradiation.

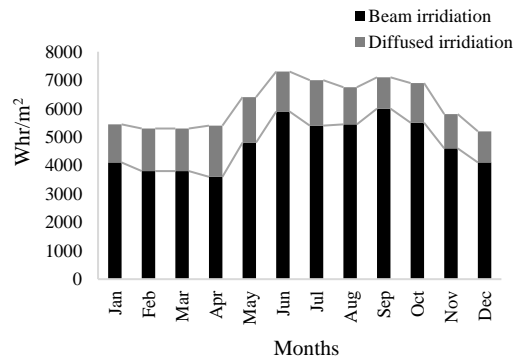

Fig. 9. The O.S. monthly quantities of direct and diffused irradiation.

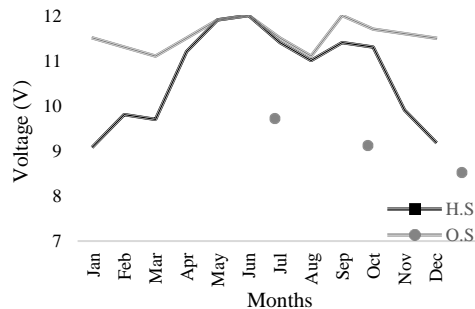

Fig. 10. Comparison of the received voltage at two fixed and optimal angles.

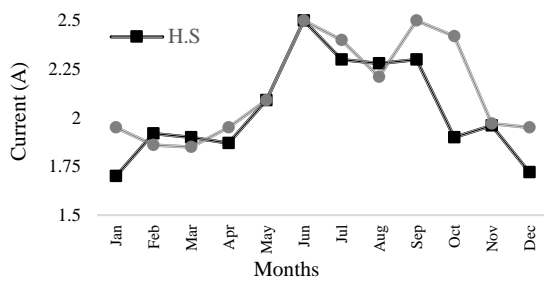

Fig. 11. Comparison of the received current at two fixed and optimal angles.

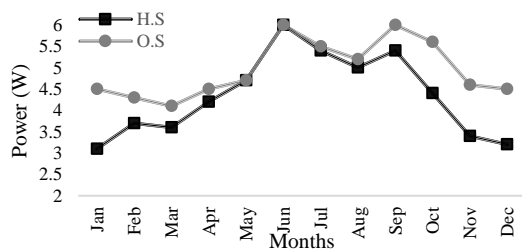

Fig. 12. Comparison of the received power at two fixed and optimal angles.

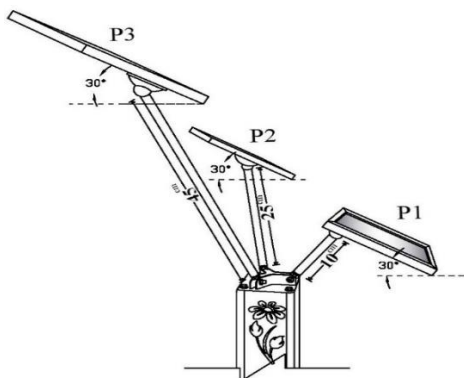

Fig. 13. The proper placements of panels on tree.

Table 6. Improved O.S efficiency compared to H.S.

Months	Percentage
Jan.	32%
Feb.	10.60%
Mar.	10.80%
Apr.	6%
May.	0%
Jun.	0%
Jul.	2%
Aug.	2%
Sep.	11%
Oct.	25%
Nov.	16%
Dec.	20%
Ann.	12%

It is obvious that by improving the slope of the structure, we have improved their efficiency. Then, the increase in efficiency in the optimal angle mode of 30 degrees and the fixed angle of zero degrees can be seen in Table 6. These changes are well visible in October, November, December, and January, which show the importance of the optimal slope in solar structures; because in the warm months of the year (May-June), the efficiency of the panels is high by itself, but in the mentioned months, usually due to cloudy or partly cloudy weather, the panel cannot easily absorb light. Helping to absorb more light offers higher efficiency and output.

Fig. 13. shows how the panels are placed on the branches of the tree. In this structure, there are three branches, each of the panels mounted on a separated branch by a joint, allowing the panels to rotate 60 degrees from the sides and rotate 120 degrees from the top. The rotation of the panels through the joint allows the tree to be in the optimal slope in any branch position and receive maximum efficiency.

4. Conclusions

The built solar tree has unique features described in detail in the article and all the steps shown in the figures and tables. The items considered in this project are reviewed below:

- Using the Fibonacci pattern to avoid the effect of shadow.
- Designing the tree for every country in the northern hemisphere of the earth by using a hinge at the back of the panel to conveniently change the angle.
- Using NRI model to estimate the solar energy potential by MATLAB software in 18 different angle
- Introducing a 30-degree angle as the optimal angle.
- Enhancing 12% of extractable energy of the tree by comparing the obtained energy in Zero degrees and 30 degrees.

References

[1] S. Dey, M. K. Lakshmanan and B. Pesala, "Analysis of Nature-Inspired Spirals for

- Design of Solar Tree.”, *InProceedings of the 7th International Conference on Advances in Energy Research*, pp. 1165-1173, (2021)
- [2] S. Kar, M. B. Deo, B. Panda, B. P. Nanda and N. Moharana, “Design of solar tree with photovoltaic panel using phyllotaxis phenomenon.”, *International Conference on Computational Intelligence for Smart Power System and Sustainable Energy*, pp. 1-4, (2020)
- [3] K. Gaikwad and S. Lokhande, "Novel maximum power point tracking (MPPT) algorithm for solar tree application," *2015 International Conference on Energy Systems and Applications*, pp. 189-193, (2015).
- [4] Y. Lv, X. Zhang and Y. Liu, “3D modeling of tree crowns and its application in solar energy potential mapping for urban neighborhoods,” *2014 IEEE Geoscience and Remote Sensing Symposium*, pp. 4808-4811, (2014)
- [5] E. Jumin, F. B. Basaruddin, Y. B. Yusoff, S. D. Latif and A. N. Ahmed, “Solar radiation prediction using boosted decision tree regression model: A case study in Malaysia.”, *Environ. Sci. Pollut. Res*, Vol. 28, pp. 26571-26583, (2021)
- [6] R. Sharma, A. H. Khan and A. K. Sharma, “New Concept for Solar Efficiency Improvement”, *InProceedings of Second International Conference on Smart Energy and Communication*, pp. 463-468, (2021)
- [7] H. Z. Al Garni and A. Awasthi, “Wright D. Optimal orientation angles for maximizing energy yield for solar PV in Saudi Arabia” *Renew. energy*, Vol. 133, pp. 538-550, (2019)
- [8] M. Rajaei and S. M. Ghorashi, “Experimental measurements of a prototype high-concentration Fresnel lens and sun-tracking method for photovoltaic panel’s efficiency enhancement”, *J. Theor. Appl. Phys.*, Vol. 9, No. 4, pp. 251-259, (2015)
- [9] R. Deep, A. Mishra, A. Agarwal, “Comparative Analysis of Solar Panel Output Power: Matrix Vs Tree Form”, *InMATEC Web of Conferences, EDP Sciences*, Vol. 307, p. 01002, (2020)
- [10] C. G. Ozoegwu, C. A. Mgbemene and P. A. Ozor, “The status of solar energy integration and policy in Nigeria”, *Renew. Sustain. Energy Rev.*, Vol. 70, pp. 457-471, (2017)
- [11] N. M. Kumar, S. S. Chopra, M. Malvoni, R. M. Elavarasan and N. Das, “Solar Cell Technology Selection for a PV Leaf Based on Energy and Sustainability Indicators—A Case of a Multilayered Solar Photovoltaic Tree”, *Energies*, Vol. 13, No, 23, p. 6439.
- [12] DJ. Yang, Z. F. Yuan, P. H. Lee, H. M. Yin, “Simulation and experimental validation of heat transfer in a novel hybrid solar panel”, *Int. J. Heat Mass Transf*, Vol. 55, No. 4, pp.1076-1082, (2012)
- [13] X. Tang, Z. Quan and Y. Zhao, “Experimental investigation of solar panel cooling by a novel micro heat pipe array”, *Energy Power Eng*. Vol. 2, No. 3, pp. 171-174, (2010)
- [14] S. Dey, M. K. Lakshmanan and B. Pesala, “Tuning the Solar Power Generation Curve by Optimal Design of Solar Tree Orientations.”, *Inadvances in Energy Research*, Vol. 1, pp. 461-469, (2020)
- [15] S. S. Chakrabarti, A. Pandey and P. Dhage, “A systematic approach for a better thermal management of photovoltaic systems- A review”, *Jour. of comput. and appl. Res. in mech. Eng.*, Vol. 10, No. 1, pp. 1-24, (2020)
- [16] M. Rajaei and K. challasi, “Experimental study of the effect of dust and sand on photovoltaic modules”, *Int. J. Sci. Environ. Technol*, In press, (2020).
- [17] V. Gupta, P. Raj, A. Yadav, P. Garg and F. Nizam, “Investigate the Effect of Dust Deposition on the Performance of Solar PV Module using LABVIEW based Data Logger”, *2017 IEEE International Conference on Power, Control, Signals and Instrumentation Engineering (ICPSCI 2017)*, pp. 742-747, (2017)
- [18] A. Syafiq, A. K. Pandey, N. N. Adzman and N. A. Rahim, “Advances in

- approaches and methods for self-cleaning of solar photovoltaic panels”, *Sol. Energy*, Vol. 162, pp. 597-619, (2018)
- [19] F. Hyder, P. Baredar, K. Sudhakar and R. Mamat, “Performance and land footprint analysis of a solar photovoltaic tree”, *Journal of cleaner production*, Vol. 187, pp. 432-48, (2018)
- [20] “Renewable Energy Statistics 2019”, (2019).
- [21] F. Hyder, P. Baredar and K. Sudhakar, “A novel Sun tracking technique through a Solar PV Tree and a smart controller”, *2018 4th International Conference on Electrical Energy Systems (ICEES)*, pp. 407-411, (2018)
- [22] E. Duque, A. Isaza, P. Ortiz, S. Chica, A. Lujan and J. Molina, "Urban sets innovation: Design of a solar tree PV system for charging mobile devices in Medellin — Colombia," *2017 IEEE 6th International Conference on Renewable Energy Research and Applications (ICRERA)*, pp. 495-498, (2017)
- [23] V. Renugadevi, “An approach to solar power tree”, *2017 IEEE International Conference on Electrical, Instrumentation and Communication Engineering (ICEICE)*, Vol. 27, pp. 1-3, (2017).
- [24] J. Balaji, P. N. Rao and S. S. Rao, “Solar Tree with Different Installation Positions of Photovoltaic Module-Part”, *J Environ Eng (New York)*, Vol. 10, pp. 2710-2727, (2020)
- [25] H. Khan and P. Gaur, “Design of solar tree with photovoltaic panels using Fibonacci pattern”, *Adv. Res. Electr. Electron. Eng.*, Vol. 2, No. 10, pp. 67-71, (2015)
- [26] M. M. Peiravi, J. Alinejad and D. D. Ganji, “Maddah S. 3D optimization of baffle arrangement in a multi-phase nanofluid natural convection based on numerical simulation”, *Int J. number method H.*, Vol. 30, No. 5, pp. 2583-2605 (2019)
- [27] M. M. Peiravi and J. Alinejad, “Hybrid conduction, convection and radiation heat transfer simulation in a channel with rectangular cylinder”, *J. Therm. Anal.h Calorim*, Vol. 140, pp. 2733–2747 (2020).
- [28] M. Jahangiri, O. Nematollahi, E. Heidari Soorshjani and A. Heidari Soorshjani, “Investigating the current state of solar energy use in countries with strong radiation potential in asia using GIS software, a review.”, *J. Sol. Energy*, Vol. 5, No. 3, pp. 477-497, (2020)
- [29] S. N. Maity, “Development of solar power tree – an innovation that uses up very less land and yet generates much more energy from the sun rays by SPV method.”, *J. Environ. Nanotechnol.*, Vol. 2, pp. 59–69, (2013).
- [30] S. Gupta and M. Gupta, “The benefits and applications of solar tree with natural beauty of Trees”, *Int. J. Electr. Electron. Eng.*, Vol. 3, pp. 29–34, (2015).
- [31] M. Patil Deepak, R. Madiwal Santosh, “Design and development of solar tree for domestic applications”, *Int. J. Eng. Sci. Res. Technol.*, Vol. 5, No. 8, pp. 102-111, (2016).
- [32] S. Khatoon and H. Khan, “Comparative study of Fibonacci pattern and conventional pattern of solar cell”, *2017 6th International Conference on Computer Applications In Electrical Engineering-Recent Advances (CERA)*, pp. 158-163, (2017).
- [33] D. Day and B. Pesala, “Solar tree design framework for maximized power generation with minimized structural cost”, *Renew. Energy*, Vol. 162, pp. 1747-1762, (2020).
- [34] No. 13/445/717, Photovoltaic array utilizing phyllotaxic architecture, Dwyer AR, Dwyer SP, (2012).
- [35] S. Day, M. K. Lakshmanan and B. Pesala, “Optimal solar tree design for increased flexibility in seasonal energy extraction”, *Renew. Energy.*, Vol. 125, pp.1038-1048, (2018).
- [36] A. H. Khashani, P. S. Izadkhast and A. Asnaghi, “Mapping of solar energy potential and solar system capacity in Iran.”, *Int. J. Sustain. Energy*, Vol. 33, No. 4, pp. 883-903, (2014)

Copyrights ©2021 The author(s). This is an open access article distributed under the terms of the Creative Commons Attribution (CC BY 4.0), which permits unrestricted use, distribution, and reproduction in any medium, as long as the original authors and source are cited. No permission is required from the authors or the publishers.



How to cite this paper:

Meraj Rajaee and Mina Jalali, "Analysis and implementation of the solar tree by determining the optimal angle in Shiraz-Iran," *J. Comput. Appl. Res. Mech. Eng.*, Vol. 12, No. 1, pp. 95-107, (2022).

DOI: 10.22061/jcarme.2021.8079.2076

URL: https://jcarme.sru.ac.ir/?_action=showPDF&article=1598

